

5½ in 20 lb/ft

Clearance: Standard

Label	Pin/Box	OD [mm]	ID [mm]	Min. Turning Length [mm]	Min. Boring Length [mm]	OD [in]	ID [in]	Min. Turning Length [in]	Min. Boring Length [in]
5½ in 20 lb/ft	BOX	154.90 ± 0.50	119.60 ± 0.20	133.00	133.00	6.098 ± 0.020	4.709 ± 0.008	5.236	5.236
	PIN	140.05 ± 1.04	120.40 ± 0.20	138.00	138.00	5.514 ± 0.041	4.740 ± 0.008	5.433	5.433

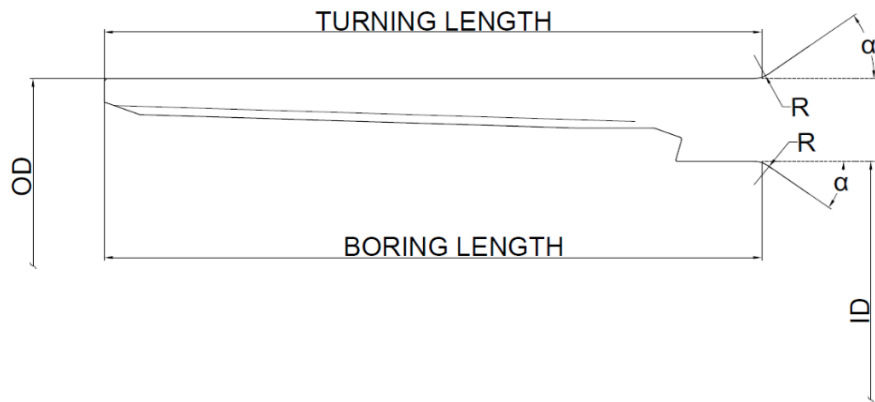

BOX

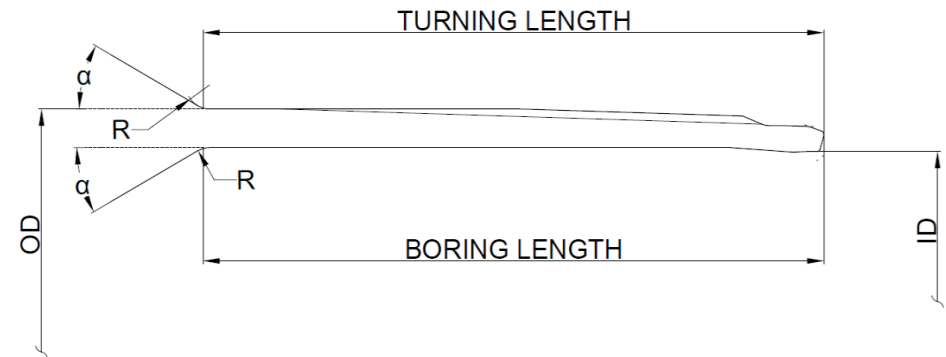

PIN

$R_{\min} = 20 \text{ mm} = 0.79 \text{ in}$

$\alpha_{\min} = 30^\circ$



www.sentinelconnections.com

PCBD-SENTINEL_Prime-5.5-20

Date of issue (dd/mm/yyyy): 31/10/2024